



## chelsea™ Specialty Shutter Order Form

<b>CUSTOMER INFORMATION</b>			SHIP TO			Shipping Methods		
Company:			Company:			<input type="radio"/> Residential <span style="margin-left: 150px;"><input type="radio"/> Regular Via Ground</span>		
Account ID:			Address Line 1			<input type="radio"/> Commercial <span style="margin-left: 150px;"><input type="radio"/> Expedite via Ground</span>		
Contact			Address Line 2			<input type="radio"/> Express <span style="margin-left: 150px;"><input type="radio"/> Will Call</span>		
P.O. Number:		Order Date	City / State		Zip:			
Sidemark:			Telephone:		Fax:	Installer: _____		

1 Line #	2 Room	3		4 Hinge Color	5 Louver Size	6 Frame Type	7 Mount		8 Frame Extension	9 No. of Sides	10 Sill Option	11 Sill Location	12 Shutter				13 Panel Configuration
		Match with Line #	Color Code/ Name				IM	OM					MFF	WS	Width	Overall Height	
1																	
2																	
3																	
4																	
5																	

1 Line #	14 Stile		15 T Post		15 Width		15 Extension		16 Tilt Rod		16 Split		17 Divider Rail Location		18 Legs			19 Specialty Shapes		20 Qty	Surcharge	Subtotal	Total
	Type	Default	Qty	Location	Standard or 2"	Standard/ Custom	Standard/ Hidden Tilt/ Offset	Equally / Specify	Center	Other (specify)	(C) Left Side Leg	(B) Middle Leg	(D) Right Leg	Type	Template								
1																							
2																							
3																							
4																							
5																							

**Special Instructions:** \_\_\_\_\_

\_\_\_\_\_

\_\_\_\_\_

\_\_\_\_\_

Subtotal

Sales Tax (CA Merchant)

Grand Total

## chelsea™ Specialty Shutter Key Chart:

**1) Item#:** Start with Window #1 and continue.

**2) Room:** Window location.

**Window Type:** Single/ Side by side / Bay window/  
Corner window

**Match with Line No.:** Fill in the Item # if applicable.

**3) Color:**

Please refer to color chart

**4) Hinge Finish:**

White	Off White
Antique Brass	Bright Brass
Stainless	Oil Rubbed

**5) Louver Size:**

Elliptical: 2 ½", 3 ½", 4 ½".

**6) Frame Type:**

Deco Frame:

2" Deco Frame  
3" Deco Frame

L Frame:

Beaded L Frame  
Bullnose L Frame  
Colonial L Frame

Z Frame:

Beaded Z Frame  
Bullnose Z Frame  
1 ¾" Deco Z Frame  
2" Crown Z Frame  
3" Crown Z Frame

Hang Strip:

1 1/16" Hang Strip  
Light blocks (top and bottom) will be provided

Buildout:

Standard Extension: ½", 1", or 1 ½"  
Custom Extension: Up to 2"

**7) Mount Type:** Inside Mount = IM      Outside Mount = OM

**8) Frame Extension\*:**

Deco Frame:

Standard Extension: ½", 1", or 1 ½"  
Custom extension: up to 2"

L Frame:

Standard Extension: ½", 1", or 1 ½"  
Custom extension: up to 2"

Hang Strip (OM):

Standard Extension: ½", 1", or 1 ½"  
Custom extension: up to 2"

Z frame:

Standard Extension: ½", 1", or 1 ½"  
Custom extension: up to 2"

**9) No. of sides:** Number of frame sides.

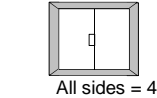
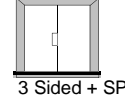
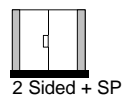
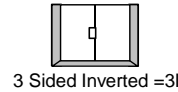
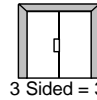

**10) Sill Option:**

Sill plate (SP)  
Sill Cap (SC)

**11) Sill Plate/Cap Location:** Top / Bottom/ Left / Right

**12) Shutter:**

Max Frame to Frame Size= MFF      Window Size= WS

**Width / Height:** Indicate shutter width and height

**13) Panel Configuration:** Indicate configuration from left to right.

Left = L  
Right = R  
T = T post

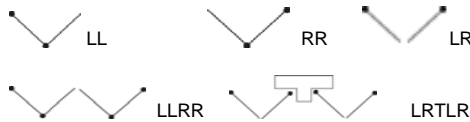

**14) Stile:** Butt / Rabbet / Astragal

Default: 2" Butt – Single Panel  
2" Astragal – Multiple Panel

**15) T Post**

**Quantity:** Specify quantity

**Location:**

Center

**Width:**

1.25" or 3.5" (face width)

**Extension:**

Standard Extension: ½", 1", or 1 ½"  
Custom extension: up to 2"

**16) Tilt Rod:**

Hidden Tilt\* will be spliced  
if the tilt bar exceeds 39". Default location is on the  
hinged side.

**Split Tilt Rod:**

Split equally = C

Other= Specify location

**17) Divider Rail Location:**

Required for all panels over 74" in height.  
Divide in the center = Check "Center"  
Other = Specify Center of Rail Location

Please refer to program manual for details on deviation.

**18) Height Details**

Contoured / Arch Top

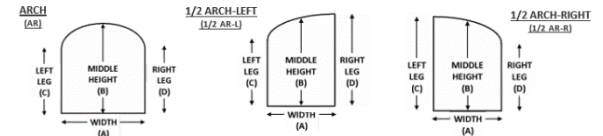

Rake / Angel Top

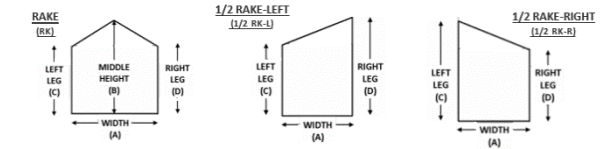

Circle & Eyebrow

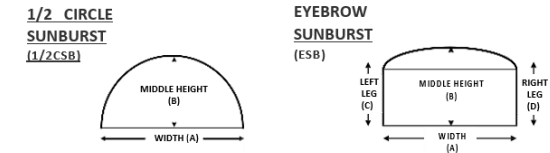

**19) Specialty Shape\*:**

**Type:** Indicate specialty shape

**Template:**

Will send template: Yes

No template: No

**20) Qty:** Numbers of windows of the same specification.



## chelsea™ Specialty Shutter Order Form

<b>CUSTOMER INFORMATION</b>			SHIP TO			Shipping Methods		
Company:			Company:			<input type="radio"/> Residential <span style="margin-left: 150px;"><input type="radio"/> Regular Via Ground</span>		
Account ID:			Address Line 1			<input type="radio"/> Commercial <span style="margin-left: 150px;"><input type="radio"/> Expedite via Ground</span>		
Contact			Address Line 2			<input type="radio"/> Express <span style="margin-left: 150px;"><input type="radio"/> Will Call</span>		
P.O. Number:		Order Date	City / State		Zip:			
Sidemark:			Telephone:		Fax:	Installer: _____		

1 Line #	2 Room	3 Window Type	4 Match with Line #	5 Color Code/ Name	6 Hinge Color	7 Louver Size	8 Frame Type	9 Mount		10 Frame Extension	11 No. of Sides	12 Sill Option	13 Sill Location	14 Shutter				15 Panel Configuration
								IM	OM					MFF	WS	Width	Overall Height	
1																		
2																		
3																		
4																		
5																		

1 Line #	14 Stile		15 T Post		16 Width Extension		17 Tilt Rod Split		18 Divider Rail Location		19 (C) Left Side Leg	20 (B) Middle Leg	21 (D) Right Leg	22 Specialty Shapes		23 Qty	24 Surcharge	25 Subtotal	26 Total
	Type	Default	Qty	Location	Standard or 2"	Standard/ Custom	Standard/ Hidden Tilt/ Offset	Equally / Specify	Center	Other (specify)				Type	Template				
1																			
2																			
3																			
4																			
5																			

**Special Instructions:** \_\_\_\_\_

\_\_\_\_\_

\_\_\_\_\_

\_\_\_\_\_

Subtotal

Sales Tax (CA Merchant)

Grand Total

## chelsea™ Specialty Shutter Key Chart:

**1) Item#:** Start with Window #1 and continue.

**2) Room:** Window location.

**Window Type:** Single/ Side by side / Bay window/  
Corner window

**Match with Line No.:** Fill in the Item # if applicable.

**3) Color:**

Please refer to color chart

**4) Hinge Finish:**

White	Off White
Antique Brass	Bright Brass
Stainless	Oil Rubbed

**5) Louver Size:**

Elliptical: 2 ½", 3 ½", 4 ½".

**6) Frame Type:**

Deco Frame:

2" Deco Frame  
3" Deco Frame

L Frame:

Beaded L Frame  
Bullnose L Frame  
Colonial L Frame

Z Frame:

Beaded Z Frame  
Bullnose Z Frame  
1 ¾" Deco Z Frame  
2" Crown Z Frame  
3" Crown Z Frame

Hang Strip:

1 1/16" Hang Strip  
Light blocks (top and bottom) will be provided

Buildout:

Standard Extension: ½", 1", or 1 ½"  
Custom Extension: Up to 2"

**7) Mount Type:** Inside Mount = IM    Outside Mount = OM

**8) Frame Extension\*:**

Deco Frame:

Standard Extension: ½", 1", or 1 ½"  
Custom extension: up to 2"

L Frame:

Standard Extension: ½", 1", or 1 ½"  
Custom extension: up to 2"

Hang Strip (OM):

Standard Extension: ½", 1", or 1 ½"  
Custom extension: up to 2"

Z frame:

Standard Extension: ½", 1", or 1 ½"  
Custom extension: up to 2"

**9) No. of sides:** Number of frame sides.



2 Sided = 2

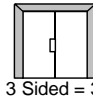

3 Sided = 3



3 Sided Inverted = 3



2 Sided + SP



3 Sided + SP



All sides = 4

**10) Sill Option:**

Sill plate (SP)  
Sill Cap (SC)

**11) Sill Plate/Cap Location:** Top / Bottom/ Left / Right

**12) Shutter:**

Max Frame to Frame Size= MFF    Window Size= WS

**Width / Height:** Indicate shutter width and height

**13) Panel Configuration:** Indicate configuration from left to right.

Left = L  
Right = R  
T = T post

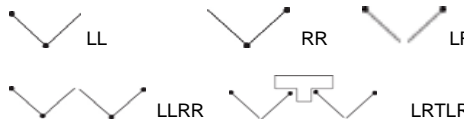

**14) Stile:** Butt / Rabbet / Astragal

Default: 2" Butt – Single Panel  
2" Astragal – Multiple Panel

**15) T Post**

**Quantity:** Specify quantity

**Location:**

Center

**Width:**

1.25" or 3.5" (face width)

**Extension:**

Standard Extension: ½", 1", or 1 ½"  
Custom extension: up to 2"

**16) Tilt Rod:**

Hidden Tilt\* will be spliced  
if the tilt bar exceeds 39". Default location is on the  
hinged side.

**Split Tilt Rod:**

Split equally = C

Other= Specify location

**17) Divider Rail Location:**

Required for all panels over 74" in height.  
Divide in the center = Check "Center"  
Other = Specify Center of Rail Location

Please refer to program manual for details on deviation.

**18) Height Details**

Contoured / Arch Top

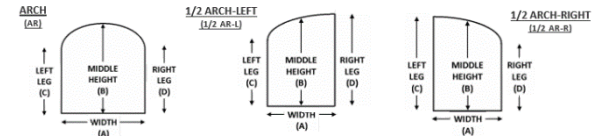

Rake / Angel Top

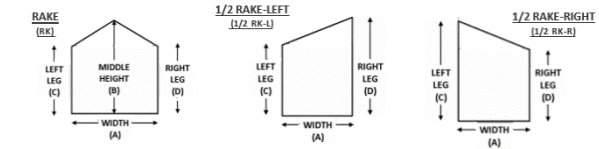

Circle & Eyebrow

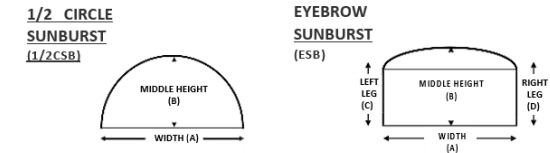

**19) Specialty Shape\*:**

**Type:** Indicate specialty shape

**Template:**

Will send template: Yes

No template: No

**20) Qty:** Numbers of windows of the same specification.

## chelsea™ French Door Shutter Order Form

<b>CUSTOMER INFORMATION</b>			<b>SHIP TO</b>			<b>Shipping Methods</b>		
Company: _____			Company: _____			<input type="radio"/> Residential <span style="margin-left: 200px;"><input type="radio"/> Regular Via Ground</span>		
Account ID: _____			Address Line 1 _____			<input type="radio"/> Commercial <span style="margin-left: 200px;"><input type="radio"/> Expedite via Ground</span>		
Contact _____			Address Line 2 _____			<input type="radio"/> Express <span style="margin-left: 200px;"><input type="radio"/> Will Call</span>		
P.O. Number: _____		Order Date _____		City / State _____		Zip: _____		
Sidemark: _____			Telephone: _____			Fax: _____		Installer: _____

1 Line #	2 Room	2 Window Type	Match with Line #	3 Color Code/ Name	4 Hinge Color	5 Louver Size	6 Frame Type	7 Shutter				8 Panel Configuration	9		10 Divider Rail Location	
								MFF	WS	Width (A)	Height (B)		Tilt Rod Standard/ Hidden Tilt/ Offset	Split Equally / Specify	Center	Other (specify)
1																
2																
3																
4																
5																

Line #	11 Cutout Type	C Bottom of shutter to bottom of cutout	D Bottom of Shutter to top of cutout	E Width of cutout	F Distance from outside of frame to start of recessed plate	G Door Trim Projection	12 Qty	Surcharge	Subtotal	Total
1										
2										
3										
4										
5										

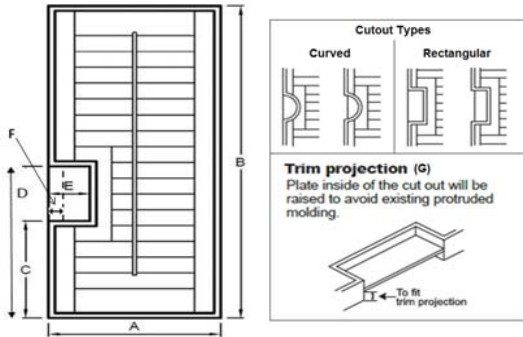

**Special Instructions:** \_\_\_\_\_

\_\_\_\_\_

\_\_\_\_\_

\_\_\_\_\_

Subtotal

Sales Tax (CA Merchant)

Grand Total

## **chelsea™ French Door Key Chart:**

**1) Item#:** Start with Window #1 and continue.

**2) Room:** Window location.

**Window Type:** Single/ Side by side

**Match with Line No:** Fill in the Item # if applicable.

**3) Color:**

Please refer to color chart

**4) Hinge Finish:**

White	Off White
Antique Brass	Bright Brass
Stainless	Oil Rubbed

**5) Louver Size:**

Elliptical: 2 ½", 3 ½", 4 ½".

**6) Frame Type:**

Beaded L Frame  
Bullnose L Frame  
Colonial L Frame

Buildout:

Standard Extension: ½", 1", or 1 ½"  
Custom Extension: Up to 2"

**7) Shutter:**

Max Frame to Frame Size= MFF Window Size= WS

**Width / Height:** Indicate shutter width and height

**8) Panel Configuration:** Indicate configuration from left to right.

Left = L Right = R

**9) Tilt Rod:**

Hidden Tilt\* will be spliced if the tilt bar exceeds 39".

Default location is on the hinged side.

Hidden Tilt\* = H

Center =C

**Split Tilt Rod:**

Split equally = Check "Center"

Other = Specify

**10) Divider Rail Location:**

Required for all panels over 74" in height.

Divide in the center = Check "Center"

Other = Specify Center of Rail Location

Please refer to program binder for details on deviation.

**11) Cutout Types:**

Routed – Frame only is routed

Curved

Rectangular

Plate will be Flush if has no door trim

Plate will be Offset if has door trim

**12) Qty:** Numbers of windows of the same specification.