

# VERTICAL BLIND INSTALLATION INSTRUCTIONS

Thank you for purchasing Patio Door Window Vertical Blinds .  
We are confident you will be pleased with their ease of  
installation, function, and quality. Please read the instructions below  
before beginning the installation process:

Package includes:

- A. Headrail (assembled with control wand)
- B. PVC Vanes
- C. Mounting Brackets
- D. Mounting Screws
- E. Valance

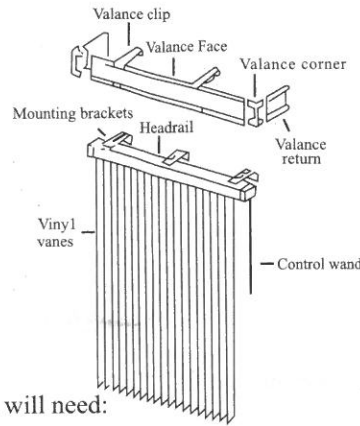

Step 1: Gather the tools you will need:

- A. Tape Measure
- B. Electric Drill
- C. Pencil
- D. Phillips Screwdriver
- E. Pair of Scissors

Step 2: Choose desired mounting method and follow instructions  
3A or 3B

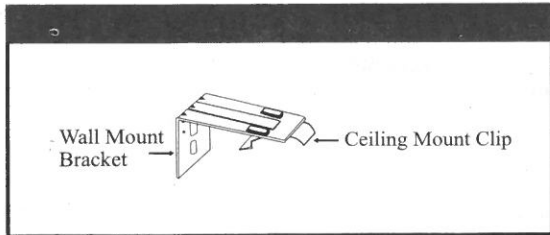

A. OUTSIDE MOUNT, Mounted on a vertical surface (wall, window, or door frame)  
STEP 3A. The length of your blind is  
the exact distance from the top of your  
headrail to the bottom of the vane. Mark  
"HEIGHT" on wall at Vane Length+2"

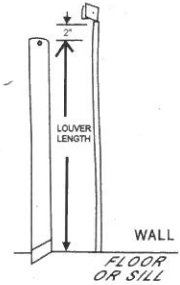

STEP 4A.

Center headrail  
over window at  
"HEIGHT" mark.  
Make about a 2" long  
mark on wall about 4" in  
from each end.

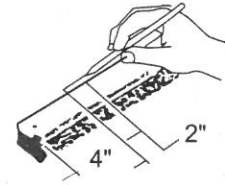

MAKE MARKS ON WALL FOR EVERY  
BRACKET, spaced evenly.

- 66 - 78" 3 BRACKETS
- 79 - 110" 4 BRACKETS

STEP 5A.

Hold brackets up to 2" marks and  
mark mounting holes on wall.



STEP 6A.

Drill holes at these marks.  
If mounting into drywall, push plastic  
wall anchors into holes. Screw brackets  
into place. Use 2 screws per bracket.



STEP 7A.

You need at least 2" between  
the back of the headrail and wall, window or any  
obstruction such as window cranks or molding for  
proper rotation of vanes.

To adjust, loosen adjusting screw and slide the clip  
out to get required clearance, then re-tighten  
adjusting screw.

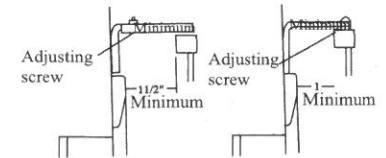

With wand and vane clips on the left side for left stack,  
or on right side for right stack, snap headrail in place by  
inserting front edge in mounting clips and rotating back.

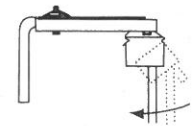

Made in China

## IF YOU NEED TO REMOVE THE BLIND:

To remove blind, release headrail by inserting a screwdriver between headrail and release tab on clip.

**B. INSIDE MOUNT,** Mounted on horizontal surface (ceiling or upper inside door/window frame)

### STEP 3B.

Hold headrail up in place. Make about a 1" long mark on inside of window frame about 4" from each end. You may use front of headrail for a guide.

MAKE MARKS ON CEILING OR FRAME FOR EVERY CLIP, spaced evenly.

66 - 78"	3 CLIPS
79 - 110"	4 CLIPS

### STEP 4B.

The mounting clips would come to you attached to the mounting brackets. The brackets are not used with this way of mounting. Loosen and remove the screw on the bottom of the bracket. Do this on all wall brackets. Discard brackets and adjusting screws and keep just the clips.

### STEP 5B.

Hold clip up to each mark you made on the ceiling or window frame so the front of the clip lines up with the mark, Mark where the hole in the clip is on the ceiling or window frame.

### STEP 6B.

Drill holes at these marks. If mounting into drywall, push plastic wall anchors into holes. Screw clip into place. Use 1 screw per clip.

### STEP 7B.

With wand and vane clips on the left side for left stack, or on right side for right stack, snap headrail in place by inserting front edge in mounting clips and rotating back.

## IF YOU NEED TO REMOVE THE BLIND

To remove blind, release headrail by inserting a screwdriver between headrail and release tab on clip.

## C. INSTALLING/REMOVING THE VANES

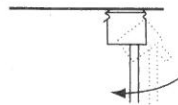
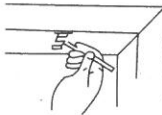
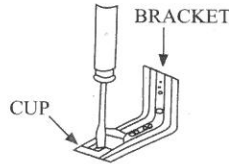
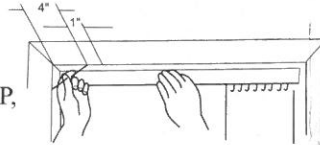
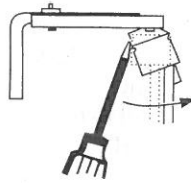

## INSTALLING:

### STEP C1.

Rotate the wand control so that the carriers are in the "open vane" position, (perpendicular to the window or wall). Pull the wand control so that the carriers are evenly spaced along the track.

STEP C2. Hold the vane near the top and gently push the vane up into the holder and down to lock it on the hook. Attach the vanes so all curves, or patterns face the same direction, Gently pull down on vane to insure it catches on stem hook.

## REMOVING:

### STEP C3.

Rotate the carries into the open position; push the vane up to the end, and then pull the vane evenly out. You can also remove vanes by inserting credit card between vane and long leg of stem.

## OPERATING INSTRUCTION

TO ROTATE the vanes, rotate the wand in the direction you want the vanes rotated.

TO OPEN OR CLOSE THE VANES, first rotate the vanes open, then push or pull the wand to open (stack vanes) or close (unstack vanes)

## IF YOU NEED TO REPLACE THE CONTROL WAND

The control wand is secured by screw to the tilt mechanism, you can just loosen the screw for replacement.

## D. INSTALLING THE VALANCE:

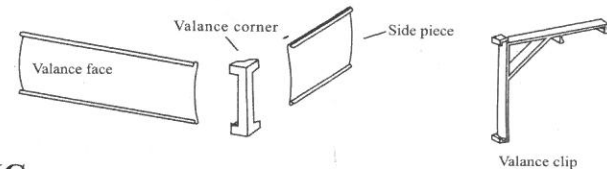

## INSTALLING:

STEP D1. Use the valance clips(1) to snap the valance(2) onto the track.

STEP D2. If you have three valance clips, one should be in the middle and the remaining two about 6" from the ends of the track. If you have four, space them evenly across the track.

STEP D3. Clip the valance face onto the valance clips attached to the track.

STEP D4. Insert vinyl vane into your valance face and the same for each small side piece.

STEP D5. To install and assemble the side pieces onto the valance face, attach the valance corner piece to both ends of the valance, then secure by inserting both side pieces.

## CARE AND CLEANING

Clean with damp cloth and a mild detergent. A thin film of detergent left on the vanes will eliminate static electricity.

